



## **NetPage Network Wireless Paging System (POCSAG)**

---

**NP-14 Series**



## **Operation Manual**

**CCW152241-002**

## **INTRODUCTION**

The NP-14 Network wireless paging system is a fully-programmable, single-board, POCSAG encoder with Hi power synthesized transmitter for the on-site paging system applications.

The unit provides a combined alarm input and link command paging solution via the external computer, console, closing contacts or the RS232 port, RJ-45 Ethernet port, provided. Which are suitable for the industrial alarm and commercial site paging, where a fast response to a security problem monitoring is essential.

The typical applications includes the Fire, Security, Nurse call system, applications. The communication to the transmitter via the RS232 port or RJ-45 port uses a relatively simple protocol by SCOPE, TAP, Comp1, Comp2,...

The NP-14 is a single-board synthesized message transmitter that operates in the 410-490MHz, 868MHz, 915MHz, 931MHz, frequency bands.

The NP-14 transmitter encoder contents, which are the capcode, speed and messages etc, can be sent by the tone-only, numeric(4-bit), alphanumeric(7-bit) using the POCSAG paging protocol out from either the serial port or from the Ethernet port.

The NP-14 option available also has 8 contacts for the alarm paging applications. Each input is an independent port control. While the contact input status from the open to short or from the short to open, the pre-programmed input capcode and message will be sent out. All programming 8 inputs paging contents must be in the same set frequency. Others such as the paging address, data rate, message, repeater call time etc can be independent either all by same and all different.

- The NP-14 Alarm contacts up to eight input control lines.
  
- The NP-14 eight contacts input are all independent.
  
- The NP-14 operates can by the RS-232 serial input.
  
- The NP-14 operates can by the RJ-45 Ethernet input.
  
- The NP-14 transmitter section is frequency synthesized unit.
  
- The NP-14 system Communicate protocol by SCOPE, COMP2...

## Appearance

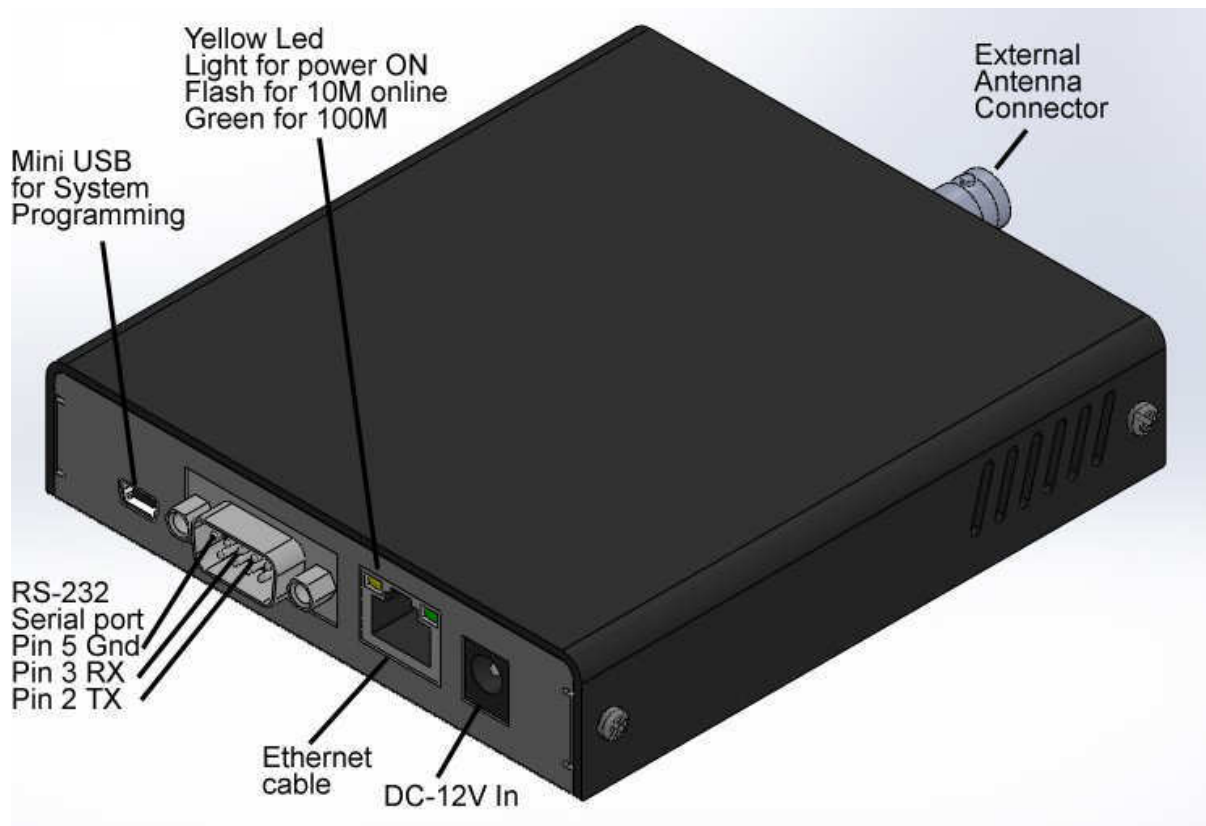

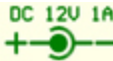
1. DC-12V IN :  10V-13.8V In Minimum 1A.
2. Ethernet cable: Connect to the Internet HUB by Cat.5 and up cable.
3. Ethernet LED indicate  
 Yellow on for power ON  
 Yellow flash for Net 10M link  
 Green flash for 100M link
4. RS-232 Serial port.  
 Pin 2 **TX** (data output To PC DB-9 Pin 2 RD)  
 Pin 3 **RX** (data received From PC DB-9 Pin 3 TD)  
 Pin 5 **GND** (required to PC DB-9 pin 5)

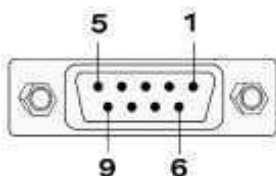

5. Mini USB for the System programming
6. RF output to antenna or RF amplifier.

# PROGRAMMABLE FEATURES

The photo screen below describes the NP-14 programmable features

**Tx Parameter**

Frequency-MHz:  Carrier frequency-MHz:  Deflection-Hz:  Tx Power-dBm:  Deviation-KHz:  Modulation:

Data Polarity:  Preamble:

---

**Key-in to paging per-program**

Pager No.	Capcode	Type	Rate	Tone	Message	Repeat
1	<input type="text" value="G 1234567"/>	<input type="text" value="A H"/>	<input type="text" value="512 I"/>	<input type="text" value="D J"/>	Door 1 Alarm <input type="text" value="K"/>	<input type="text" value="1 L"/>
2	<input type="text" value="1234568"/>	<input type="text" value="A"/>	<input type="text" value="1200"/>	<input type="text" value="D"/>	Door 2 Alarm	<input type="text" value="1"/>
3	<input type="text" value="1234569"/>	<input type="text" value="A"/>	<input type="text" value="1200"/>	<input type="text" value="D"/>	Fire case on 4FL	<input type="text" value="3"/>
4	<input type="text" value="1234570"/>	<input type="text" value="A"/>	<input type="text" value="1200"/>	<input type="text" value="D"/>	Fire case on B1	<input type="text" value="3"/>
5	<input type="text" value="1234571"/>	<input type="text" value="A"/>	<input type="text" value="1200"/>	<input type="text" value="D"/>	Strongbox Open	<input type="text" value="1"/>
6	<input type="text" value="1234572"/>	<input type="text" value="A"/>	<input type="text" value="1200"/>	<input type="text" value="D"/>	Engine room door open	<input type="text" value="1"/>
7	<input type="text" value="1234573"/>	<input type="text" value="A"/>	<input type="text" value="1200"/>	<input type="text" value="D"/>	Engine room Fire case	<input type="text" value="3"/>
8	<input type="text" value="1234999"/>	<input type="text" value="A"/>	<input type="text" value="1200"/>	<input type="text" value="C"/>	Group paging come to lobby	<input type="text" value="2"/>
9						
10						
11						
12						
13						
14						
15						
16						

---

**System program**

KeyNumber:  Buzzer:  Serial Interface:  Com set:  Protocol:  **Disconnect**

Key Action:  Debounce (sec):

↑ Figure 2. Programming screen

## Programmable and set up

**While programming, the NP-14 DC plug must be off and disconnected, Just use the DC power from PC USB.**

Tips to set up the programming parameters

1. Install the programming AP execution file

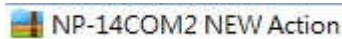

2. Click PMX-NP and then runs the programming software.

3. Connect the USB plug into the your device and the PC USB port .







If show Disconnect

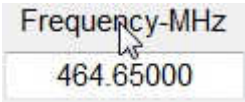
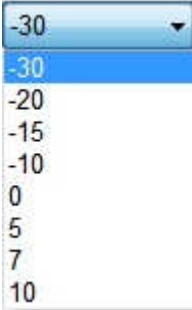

Check USB Jack again.

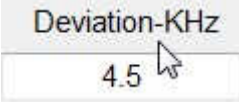
### Example Programming Screen as Below:

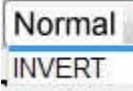
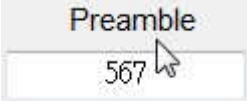
Item	Function	Value
A- Carrier Frequency 	Radio Frequency set-up key-in your own frequency	410.000 to 490.995 850.000 to 890.995 910.0000 to 931.9375
B- TX RF Power 	Transmitter RF Power set-up The % Just for reference must connect with RF power meter for true output power adjustment.	 <p>NP-14 RF power db vs W</p>
C- FSK Deviation 	Frequency Deviation set-up	Normal 4.0K or 4.5K (Max) for POCSAG or 2 level data rate
D- Modulation type select 	Frequency modulation set-up	Normal 2-FSK (2 level FSK) for POCSAG
E- Data Polarity 	Data Polarity Normal or Invert set-up	Normal = 01010101--- Invert = 10101010--- General select Normal
F- POCSAG Preamble: 	Preamble for pager power saving	Normal set 576 bits or more.

<p>G- Page number of copcode</p> <table border="1"> <thead> <tr> <th>Pager No.</th> <th>Capcode</th> </tr> </thead> <tbody> <tr><td>1</td><td></td></tr> <tr><td>2</td><td></td></tr> <tr><td>3</td><td></td></tr> <tr><td>4</td><td></td></tr> <tr><td>5</td><td></td></tr> <tr><td>6</td><td></td></tr> <tr><td>7</td><td></td></tr> <tr><td>8</td><td></td></tr> </tbody> </table>	Pager No.	Capcode	1		2		3		4		5		6		7		8		<p>Pager copcode address set-up</p>	<p>No 1-8 or 1-16 pager copcode can be all same or all difference 7digital POCSAG address range from 0000008 to 2097151.</p>
Pager No.	Capcode																			
1																				
2																				
3																				
4																				
5																				
6																				
7																				
8																				
<p>H- Pager display type selection</p> <table border="1"> <thead> <tr> <th>Type</th> </tr> </thead> <tbody> <tr><td>A</td></tr> <tr><td>A</td></tr> <tr><td>N</td></tr> </tbody> </table>	Type	A	A	N	<p>Numeric or Alphanumeric Display Pager set-up</p>	<p>N for numeric display type, A for alphanumeric display type.</p>														
Type																				
A																				
A																				
N																				
<p>I- Data Rate</p> <table border="1"> <thead> <tr> <th>Rate</th> </tr> </thead> <tbody> <tr><td>1200</td></tr> <tr><td>512</td></tr> <tr><td>1200</td></tr> </tbody> </table>	Rate	1200	512	1200	<p>Data speed set-up</p>	<p>POCSAG data speed and baud rate in 512bps or 1200bps Must to be same as pager.</p>														
Rate																				
1200																				
512																				
1200																				
<p>J- Pager alert tone</p> <table border="1"> <thead> <tr> <th>Tone</th> </tr> </thead> <tbody> <tr><td>A</td></tr> <tr><td>A</td></tr> <tr><td>B</td></tr> <tr><td>C</td></tr> <tr><td>D</td></tr> </tbody> </table>	Tone	A	A	B	C	D	<p>Pager alert tone select</p>	<p>A=1beep per Sec, B=2beeps per Sec, C=3beeps per Sec, D=4beeps per Sec.</p>												
Tone																				
A																				
A																				
B																				
C																				
D																				
<p>K- Pre-program Message</p> <table border="1"> <thead> <tr> <th>Message</th> </tr> </thead> <tbody> <tr><td>Come back please</td></tr> </tbody> </table>	Message	Come back please	<p>Pre-programmed Message</p>	<p>All ASCII words</p>																
Message																				
Come back please																				
<p>L- Paging repeater</p> <table border="1"> <thead> <tr> <th>Repeat</th> </tr> </thead> <tbody> <tr><td>4</td></tr> </tbody> </table>	Repeat	4	<p>Repeater call times for each paging</p>	<p>1=1 call 2=2 time call 3=3 time call 4=4 time call</p>																
Repeat																				
4																				

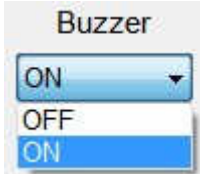
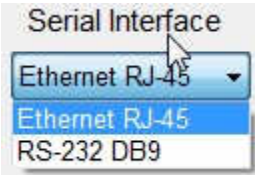
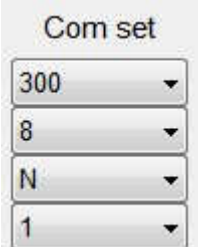
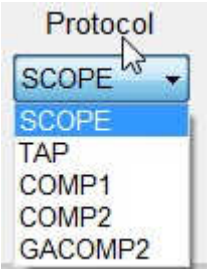
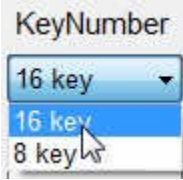
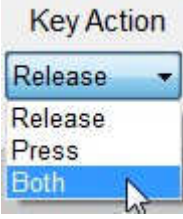
<p>M- Buzzer On/off select</p> 	<p>NP-14 TX Buzzer On or Off</p>	<p>When NP-14 Transmitter Buzzer can be set beper sound</p>
<p>N- Link interface select</p> 	<p>Command interface by RS-232 serial or by RJ-45 Ethernet</p>	<p>RJ-45 = Internet RS-232 = Serial port</p>
<p>O- PC Communication set-up</p> 	<p>O,P,Q,R-for Comport set up:</p>	<p>General set 9600,8,N,1</p>
<p>S- Command protocol</p> 	<p>PC or Console command protocol</p>	<p>SCOPE, TAP, Comp1, Comp2 GACOMP2.... Select 1 to meet your console protocol</p>
<p>T- Number of alarm input</p> 	<p>Select alarm input number 8 input or 16 input</p>	<p>The NP-14 default is 8 alarm input only</p>
<p>U- Alarm Trig switch level</p> 	<p>Select Alarm switch from NC to NO for action or NO to NC for action or any (both)</p>	<p>Release = Normal close to open Press = Normal open to short Both = Normal close to open and Normal open to close for alarm action</p>

V- Alarm Trig over time <input type="text" value="Debounce (sec)"/> <input type="text" value="1"/>	Duration action prohibited after the 1st activation	If set 1 Sec, then over 1 Sec and more time can be alarm action, if under 1 Sec is Nothin.
--	--	--

X-  X-for Read : Reading the programmed contents from your devices.

W-  W-for Write : Write the programming contents into your devices.



## INSTALLATION

### Introduction

This chapter provides basis information in installation help of the NP-14 Netpage transmitter.

### Installation

Installing the NP-14 involves identifying the interface connections for communication with the host equipment and connecting the module. The connector pin orientation is show in Figure 20 Corresponding signal name and color codes are listed in table 1-1.1-2.1-3.1-4.mount and connect the NP-14 as follows:



←Figure 20. Main I/O of Rear view

**Table 1-1.COM1,RS232 SERIAL PORTS (9 way female) PIN SIGNAL DIRECTION**

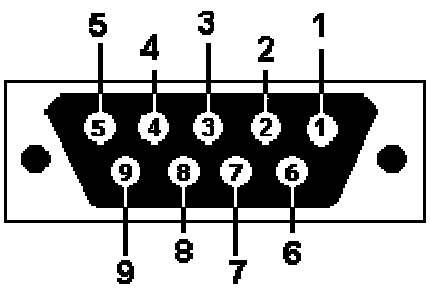
<p>DB9 - View looking into female connector (NP-14 side)</p> 	<p>1 N/C                  2 RECEIVE DATA (RX) IN                  3 TRANSMIT DATA (TX) OUT                  4 N/C                  5 GROUND (GND)                  6 N/C                  7 N/C                  8 CLEAR TO SEND (CTS) IN</p>
--	---

### Link by RS-232

Plug the RS-232 Cable into an available DB9 serial port connector on the back of a Host Device, such as a PC or Nurse Call system or other Host Device. If the serial port has a DB25 connector, you must provide a DB25 to DB9 adapter, which is available from NP-14 or from a computer supply company.

Tighten the connector screws.

Plug the RS-232 Cable into the DB9 female connector on the Transmitter Unit. Tighten the connector screws.

The RS-232 Cable is a parallel wire: Pin 2 to pin 2, Pin 3 to Pin 3. Pin 5 to pin 5.  
Option serial RS-232 cable Part NO.86852933-00

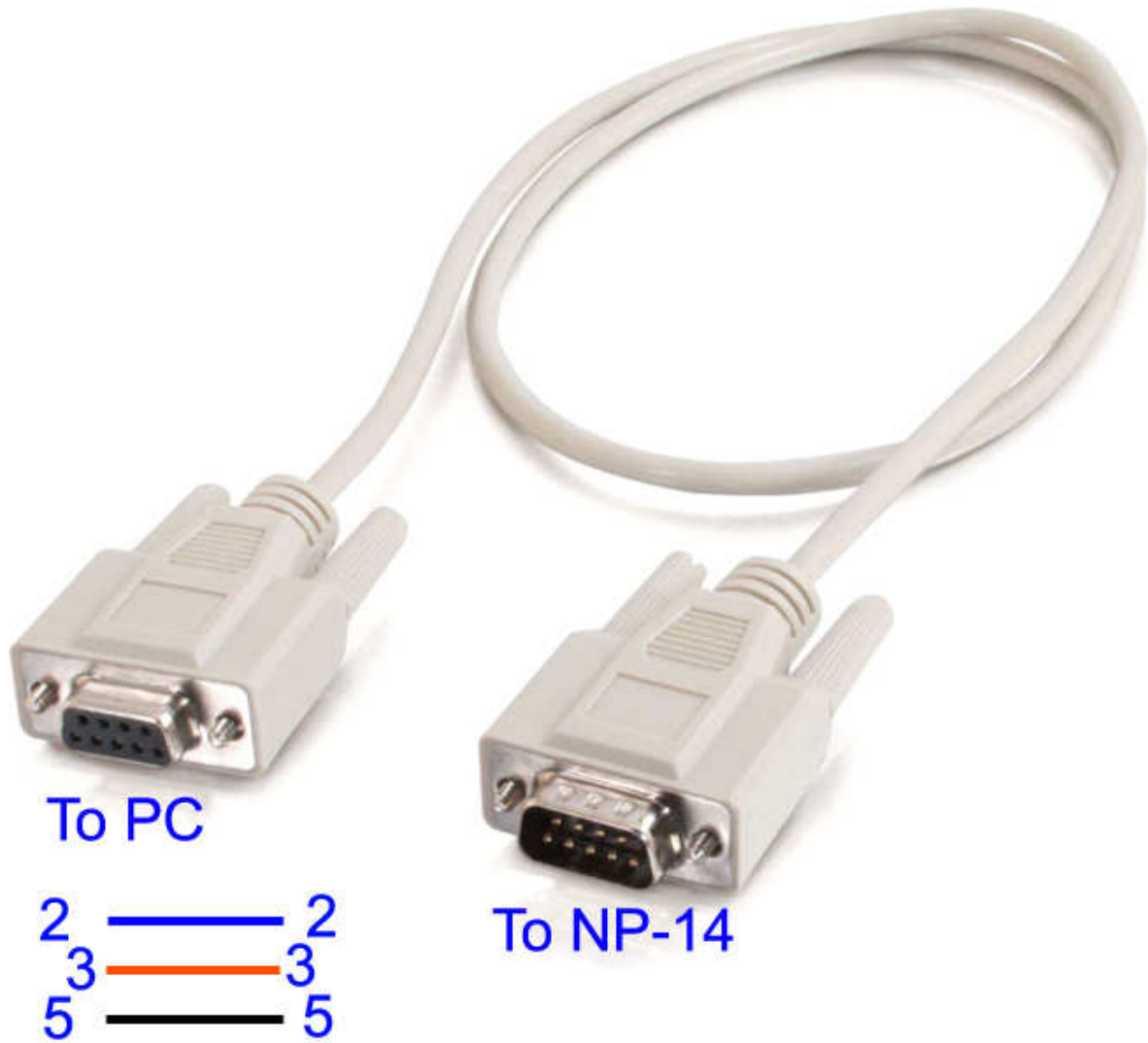

## Command Protocol

For example by Hyperterminal

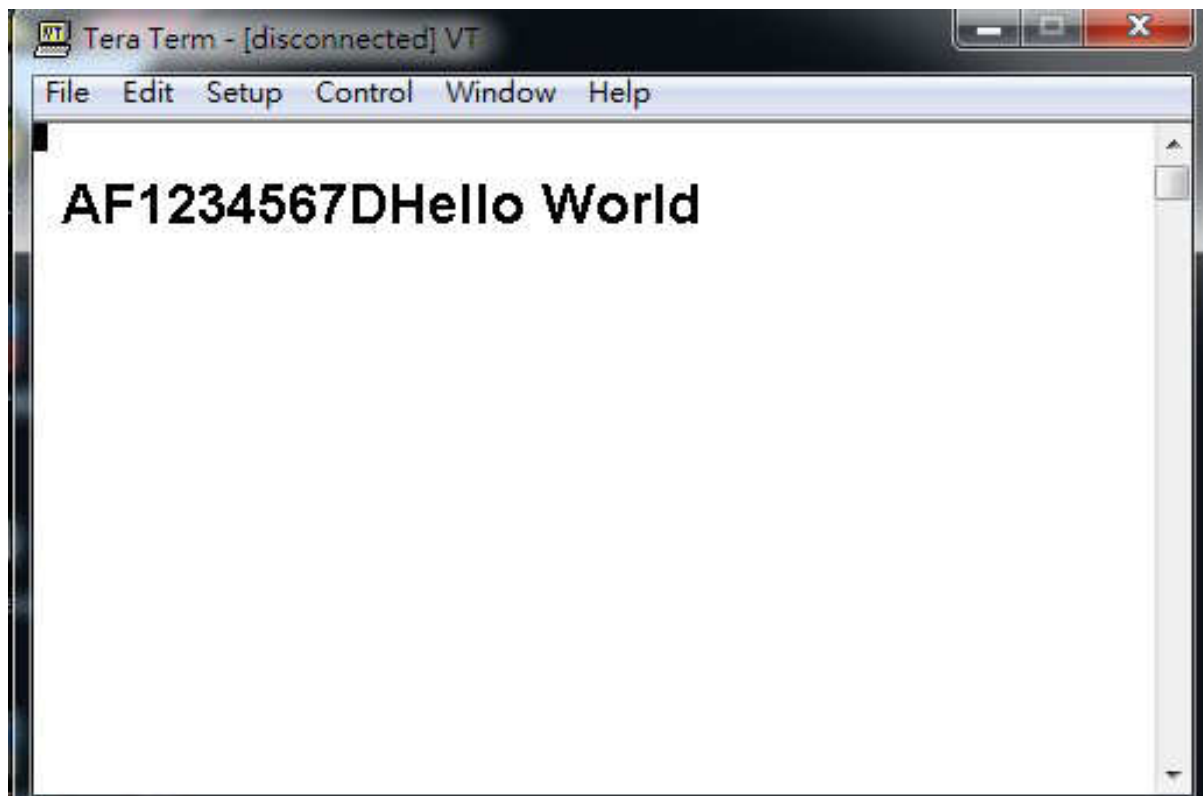

AF1234567DHello World.....

[A] Pager type Alphanumeric, N=Numeric

[F] Data bud rate, F=1200bps, N=512 bps, S=2400bps, if blank= Default 1200bps.

[1234567] Pager copcode, pager address.

[D] Pager tone alert, A for tone A, B for tone B, C for tone C, D for tone D.

[Hello World] message word.

Protocol Format Error Respond:

If the first character other than A or N --- Invalid Command format1!<CR><LF>

capcode fields appear with letter of alphabet --- Invalid Command

format2!<CR><LF>

capcode <8, >2097151 --- Capcode over range!<CR><LF>

message type field appears character out of the ABCD--- "Invalid Command

format3!\r\n"

message has the invisible character --- "Invalid Command format4!\r\n"

For example by Hyperterminal with GACOMP2 protocol

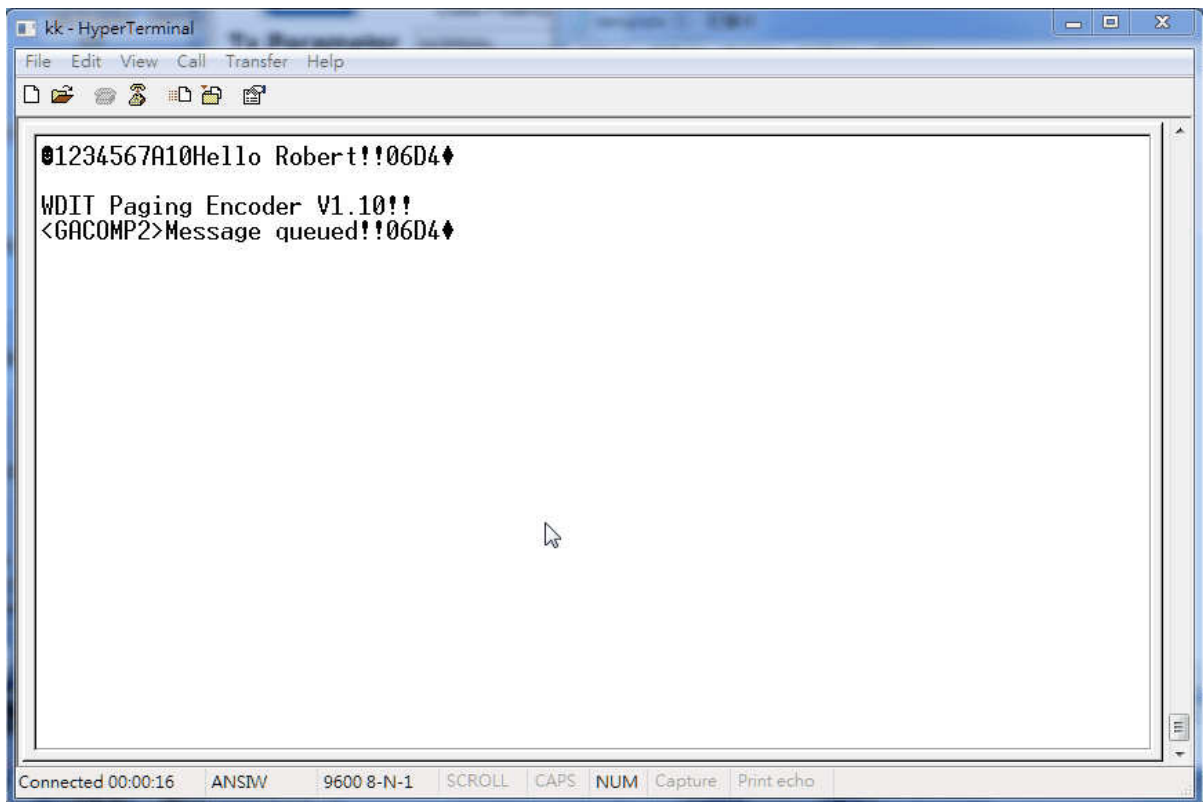
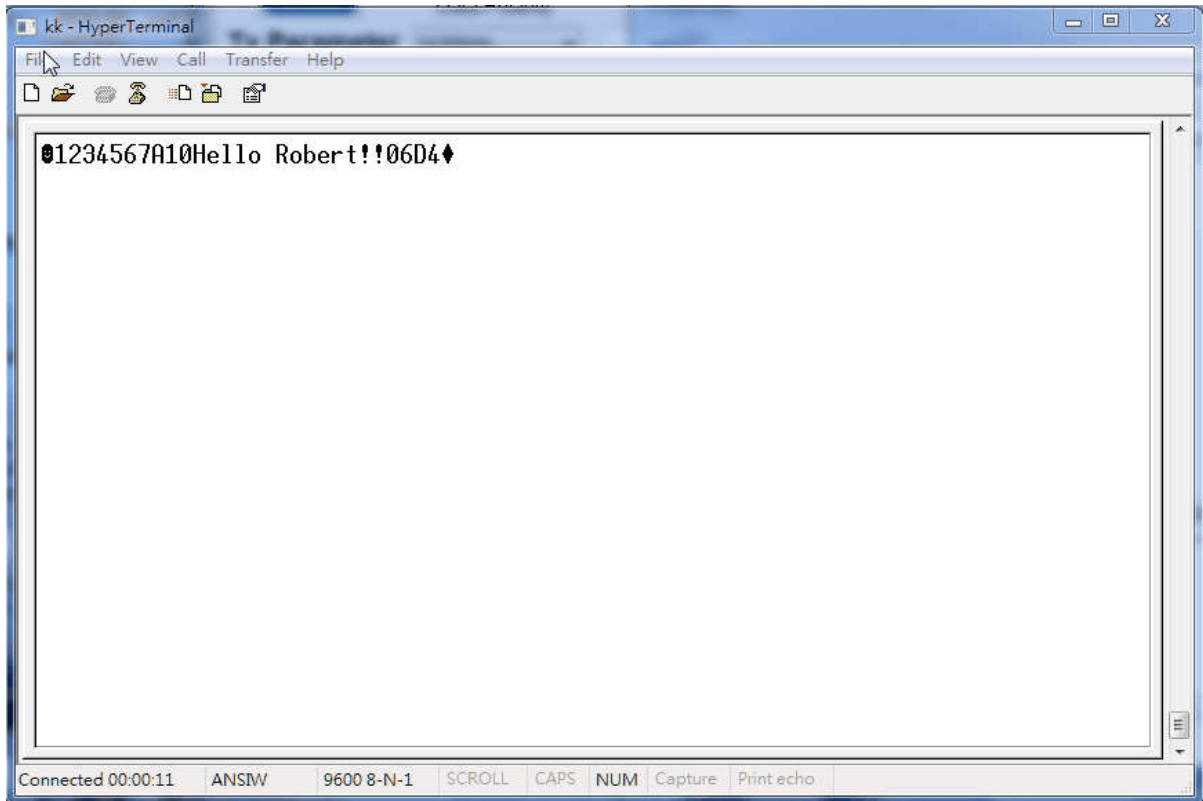

## GACOMP2 protocol V1.32

This protocol is defined for a POCSAG encoder with RS-232 in baud rate ( 9600 ,N,8,1 ) of PC .

PC send to Transmitter

Transmitter command format ( All contents is visible ASCII code exclude the STX and EOT) =

**STX** + Capcode content + Message content + CheckSum + **EOT**  
= **02H** + AAAAAAERF + Message content + **CCCC** + **04H**

Format Description :

Contents are all visible ASCII code value >= 20 Hex except the STX and EOT command

**STX** is **02** Hex code , it is not visible in ASCII code

**EOT** is **04** Hex code , it is not visible in ASCII code

Capcode content = **AAAAAAERF**

(a) **AAAAAAA** is a 7 digits numeric between 0000008 - 2097151 representing a pager or RCM receiver capcode

(b) **E** is 0,n,or **N** represent numeric encoding, and 1,a,or **A** represent alphanumeric encoding

(c) **R** is RF data rate, where **5** represents 512 bps, **1** represents 1200 bps, and **2** represents 2400 bps

(d) **F** is 0,**1,2,3**,or **4** defines the function code to be delivered.

It is 0 represent the default value for F is 4 when the E value is alphanumeric, and 1 when the E value is numeric

Numeric message = 0 to F Hex that transfer to visible ASCII code is 30H to 39H (0 – 9) and 41H to 45H (A – F).

Message content = any message you want send out ,if you did not carry any message then it will send out a "Tone Only" message output

CheckSum(**CCCC**) is a 4 number of ASCII code include all contents before CheckSum ( **STX** + Capcode content + Message content )

CheckSum example : Capcode content Message content CheckSum

EX 1. Num.1200bps **100001N11** 1234ABCD 03D8

Description :

CheckSum = 3D8H (02H+31H+30H+30H+30H+30H+30H+31H+4EH+31H+31H+31H+32H+33H+34H+41H+42H+43H+44H)

**CCCC** = 03D8 (30H,33H,44H,38H)

Total contents = 02H + "100001N111234ABCD03D8" + 04H

EX 2. Alpha 1200bps **0000128A11** abcdefghijk 0662

Description :

Checksum = 662H (02H+30H+30H+30H+30H+31H+32H+38H+41H+31H  
+31H+61H+62H+63H+64H+65H+66H+67H+68H+69H+6AH+6BH)

CCCC = 0662 (30H,36H,36H,32H)

Total contents = 02H + "0000128A11abcdefghijk0662" + 04H

EX3. Num. 512 bps **1000122N51** xxx... 6A3C

Description : CheckSum = 126A3CH ( only use last 4 digits as valid ) CCCC = 6A3C  
(36H,41H,33H,43H)

Transmitter send to PC

If command accept to transmitter then transmitter send CCCC + **ACK(06H)** to PC .  
the CCCC is check sum of message.

if command did not accept to transmitter will not send back CCCC + **ACK(06H)** within  
200 mS .

**Note: Transmitter encode message must be following two conditions then transmitter  
will encode all messages and send all messages at one time.**

**1. PC send message then receive the ACK from transmitter and PC send first byte of  
next message less than 150mS after last ACK.**

**2. Transmitter received total messages is less then 15K bytes.**

**Idle Capcode is from 2007664 to 2007671.**

Also if the NP-14 option for 8 dry alarm contacts

The following 8 Pins 2 Rows Header Connector will replace the com1 DB9 position.

**Table 1-2. 2x8 Header connector for 8 contacts alarm input**

**PIN SIGNAL DIRECTION**

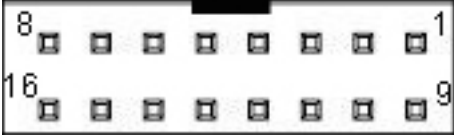
<p>Header 2x8 - View looking into connector (NP-14 side)</p> 	<ul style="list-style-type: none"> <li>1 Alarm contact 1 input</li> <li>2 Alarm contact 2 input</li> <li>3 Alarm contact 3 input</li> <li>4 Alarm contact 4 input</li> <li>5 Alarm contact 5 input</li> <li>6 Alarm contact 6 input</li> <li>7 Alarm contact 7 input</li> <li>8 Alarm contact 8 input</li> <li>9 -16 Ground</li> </ul> <p>Each alarm switch NO to NC, or NC to NO be alarm active.</p>
--	--

↓ More switch of alarm input information

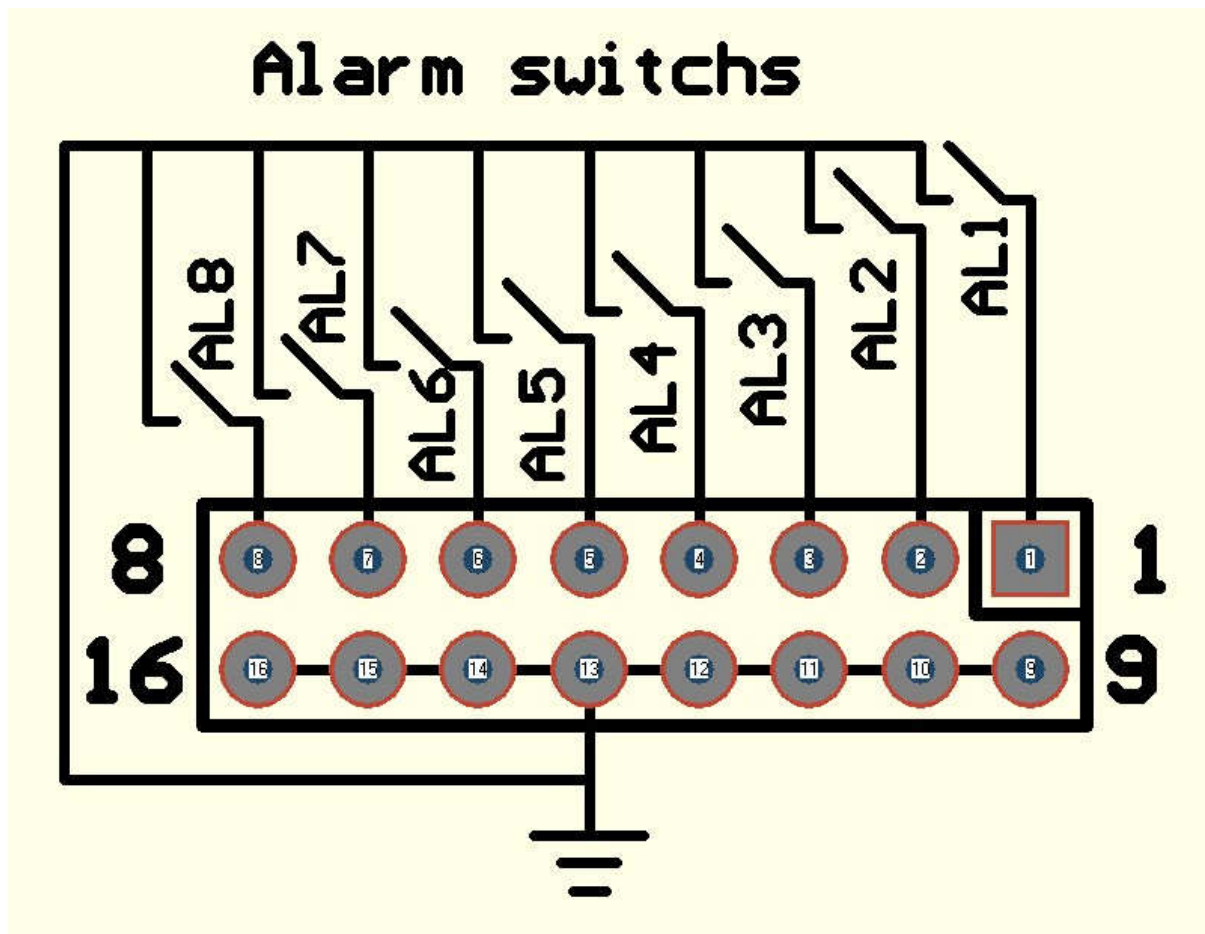

Option for external trig wires Part No. 86864528-00  
For Alarm switch or alarm sensor direct connect with wires

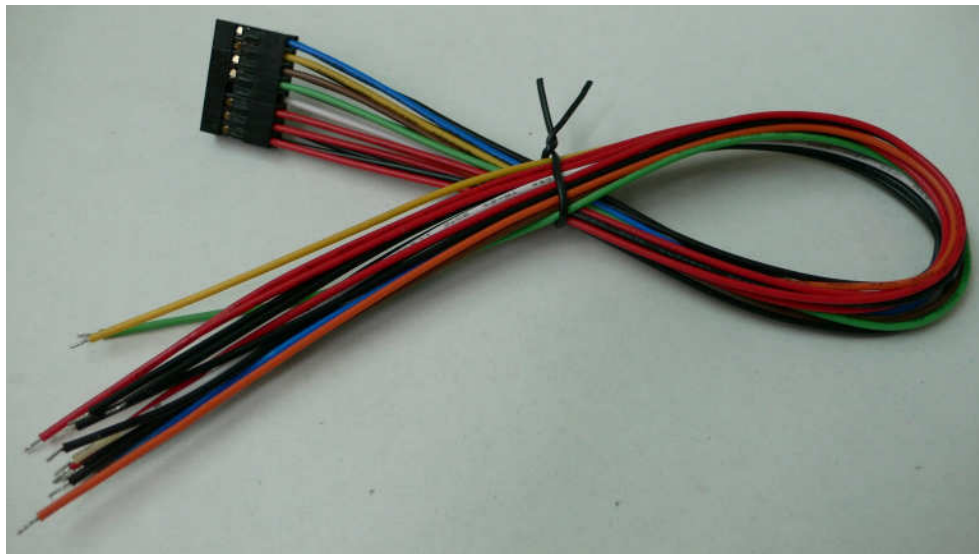

Option for external trig alarm terminal board Part No. 86864700-00  
For external terminal block

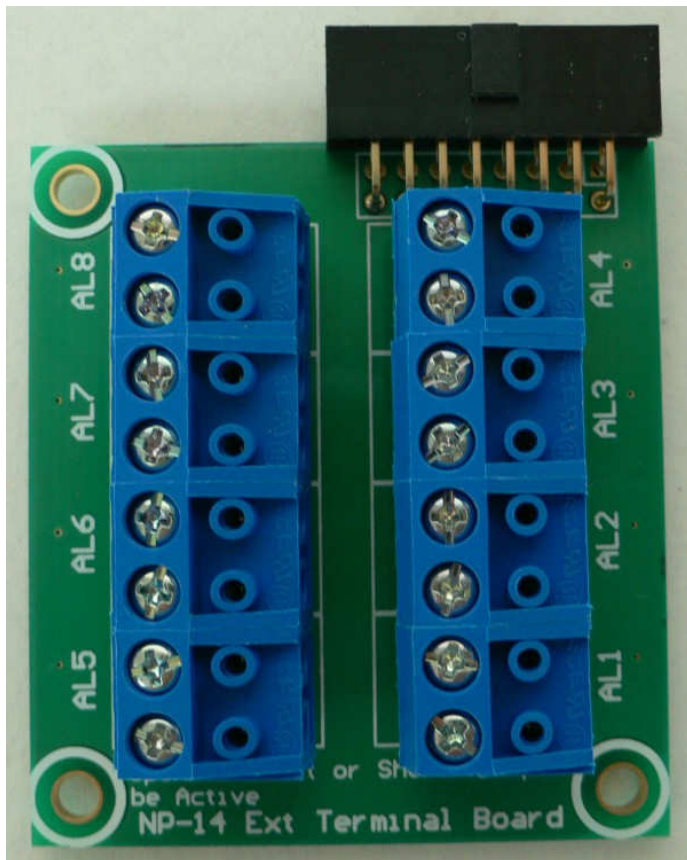



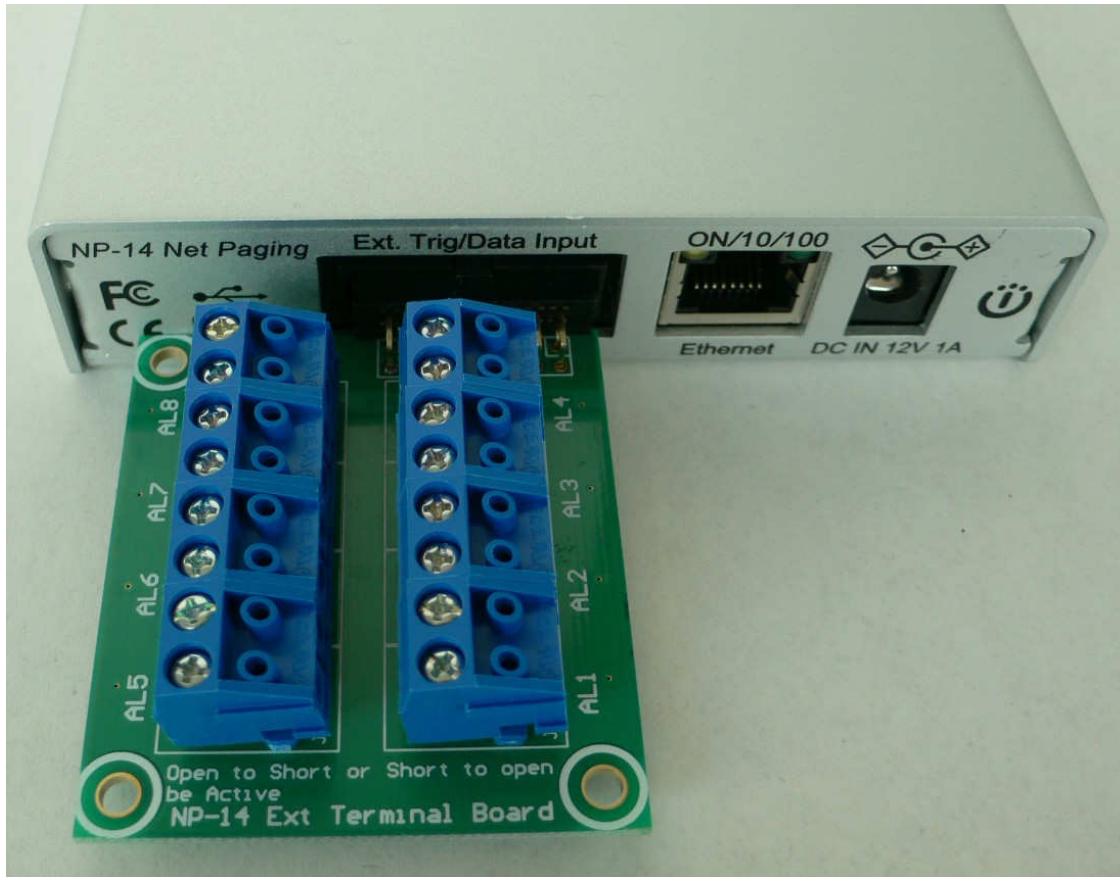

Use ext terminal board into to NP-14 Ext. trig port.

Table 1-3. Inside contacts input terminal (8 port) PIN SIGNAL DIRECTION

G	S	G	S	G	S	G	S
J15		J16		J17		J18	
AL5	AL6	AL7	AL8				
G	S	G	S	G	S	G	S
J11		J12		J13		J14	
AL1	AL2	AL3	AL4				
Open to Short or Short to open be Active							

1 AL1 Alarm 1 in S= Trigger, G=Ground  
 2 AL2 Alarm 2 in S= Trigger, G=Ground  
 3 AL3 Alarm 3 in S= Trigger, G=Ground  
 4 AL4 Alarm 4 in S= Trigger, G=Ground  
 5 AL5 Alarm 5 in S= Trigger, G=Ground  
 6 AL6 Alarm 6 in S= Trigger, G=Ground  
 7 AL7 Alarm 7 in S= Trigger, G=Ground  
 8 AL8 Alarm 8 in S= Trigger, G=Ground  
 Each contact G-S open to short, or  
 short to open be alarm active.

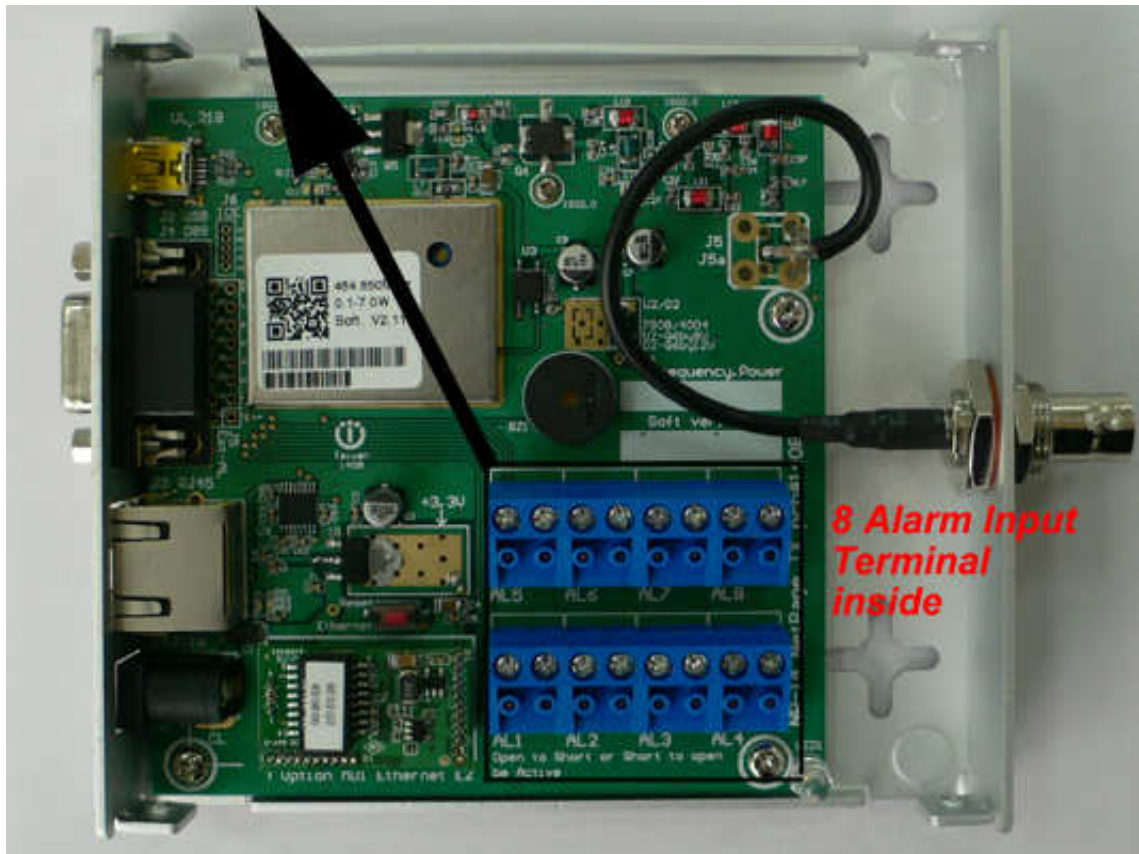



The alarm cable can be in/out on side hole of NP-14

# NP-14 Net-Paging System

## Ethernet IP set up Guide

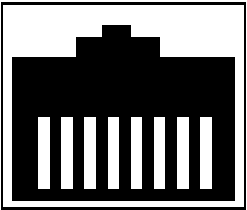
Table 1-4. RJ-45 ETHERNET PORTS (8 pin receptacle) PIN SIGNAL DIRECTION

<p>RJ-45 - View looking into receptacle (NP-14 side)</p>  <p>8 1</p>	<p>1 TD+ 2 TD- 3 RD+ 4 NA 5 NA 6 RD- 7 NA 8 NA</p>
---	--

Click →  Moxa MiiNePortE2 Driver

Click →  drvmgr\_setup\_Ver1.17\_Build\_13020109\_whql to install NPort



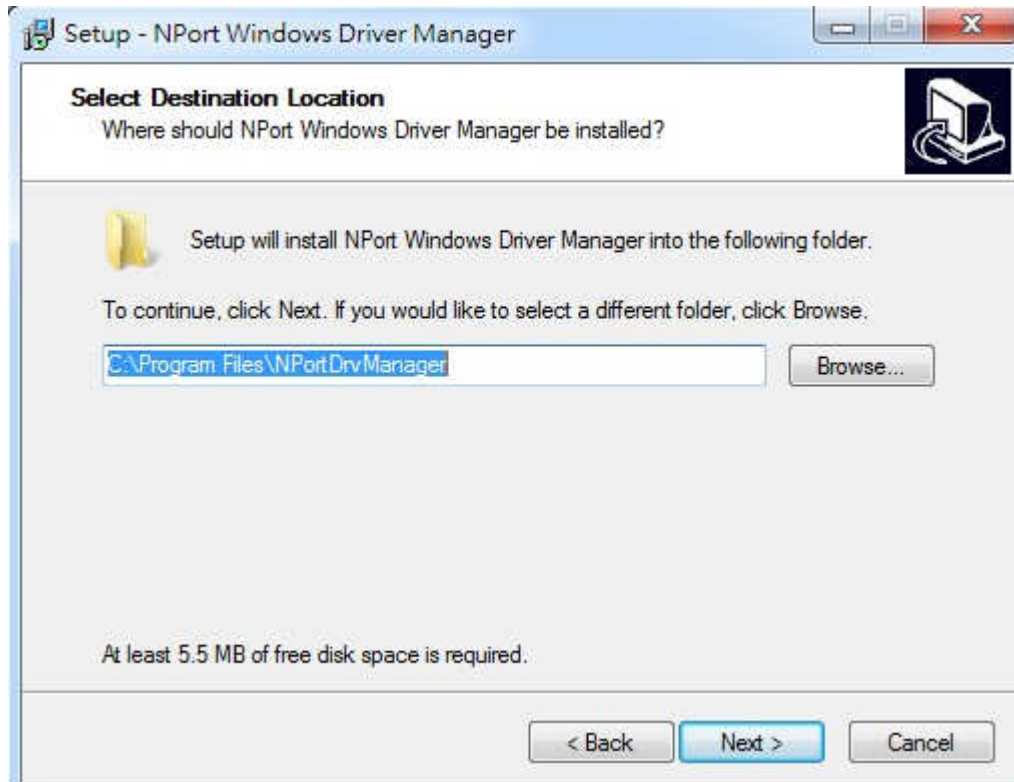

Click →Next

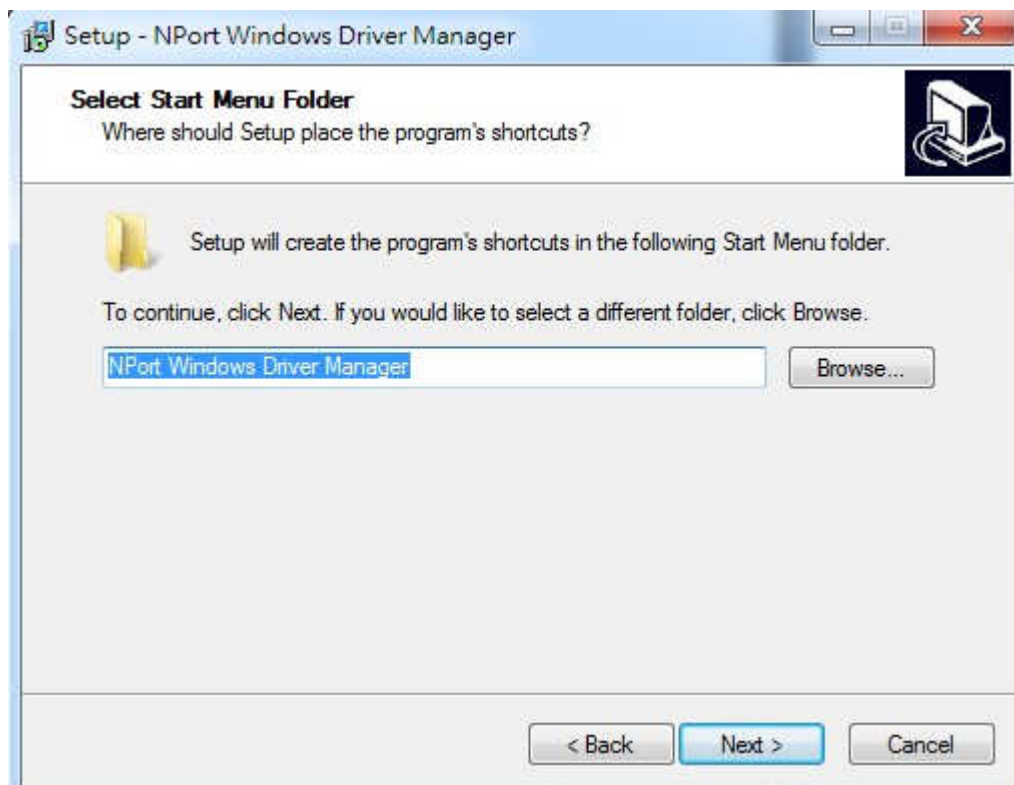

Click →Next

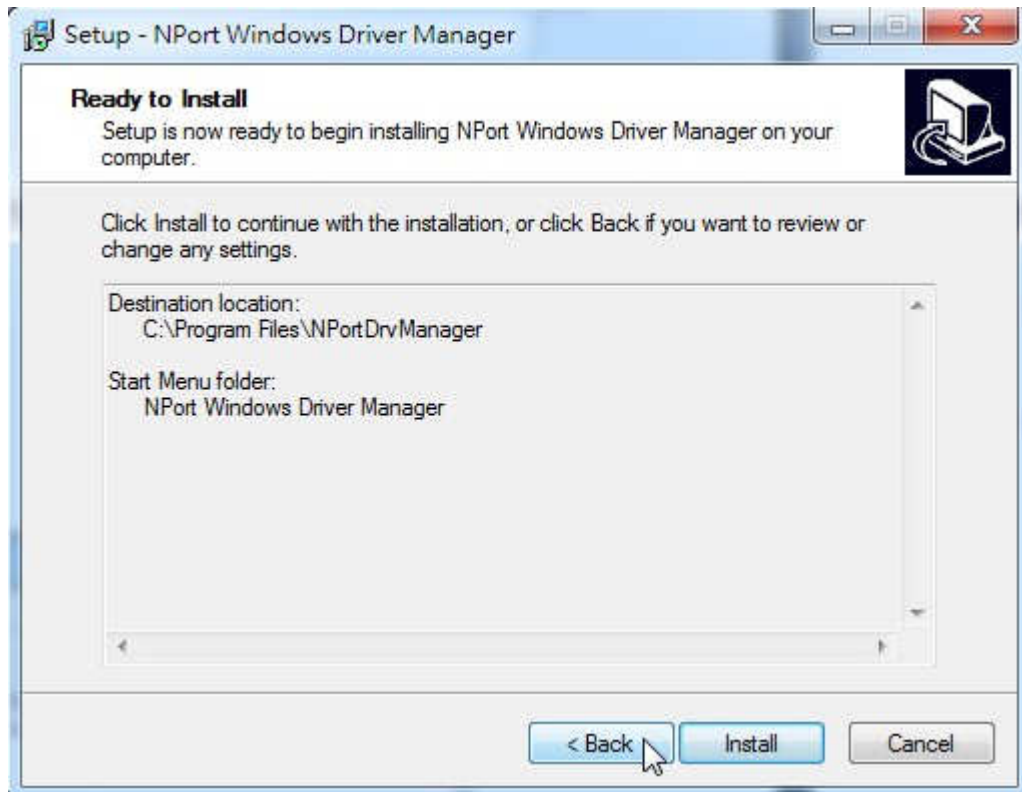

Click → Install



Click → Finish



Click your PC →start then click →Nport



 NPort Windows Driver Manager

 NPort Windows Driver Manager

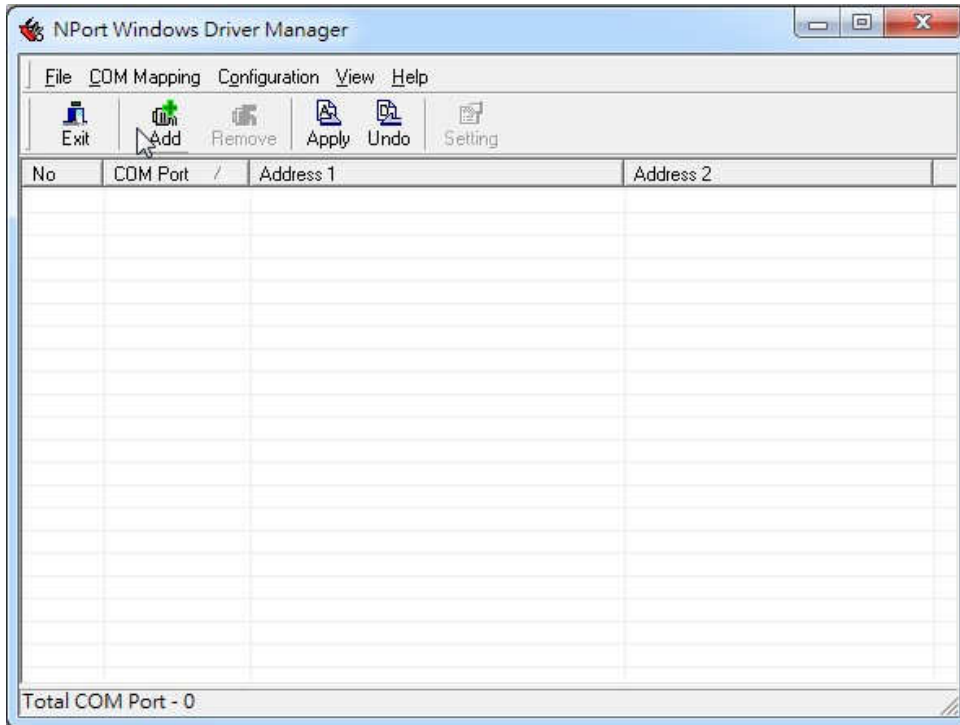

Click→



Click →Search

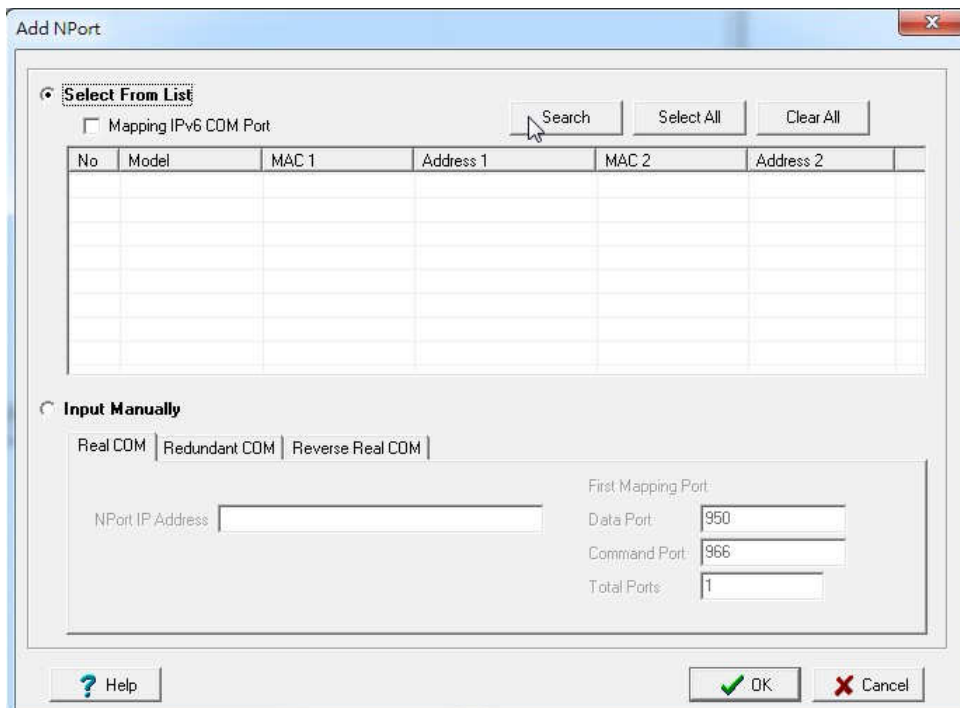

To find a IP address

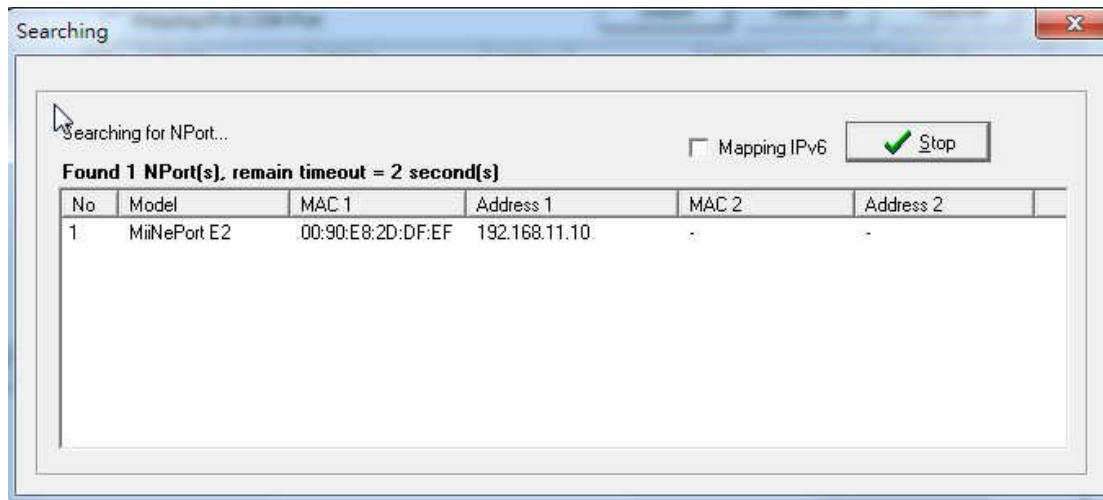

Click → OK

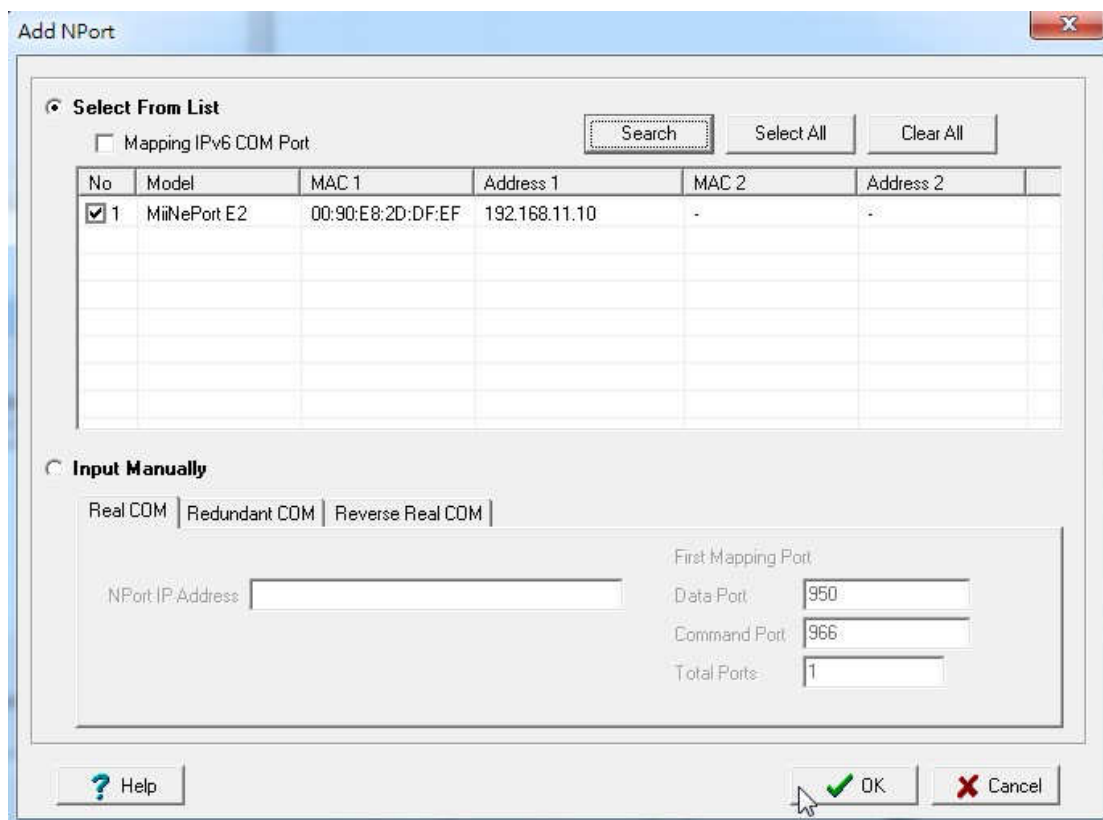

Click→ Yes

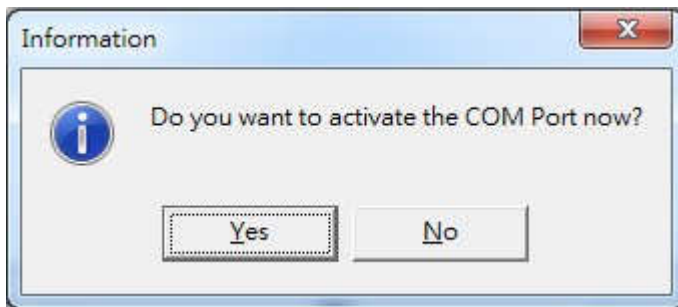

Waiting....

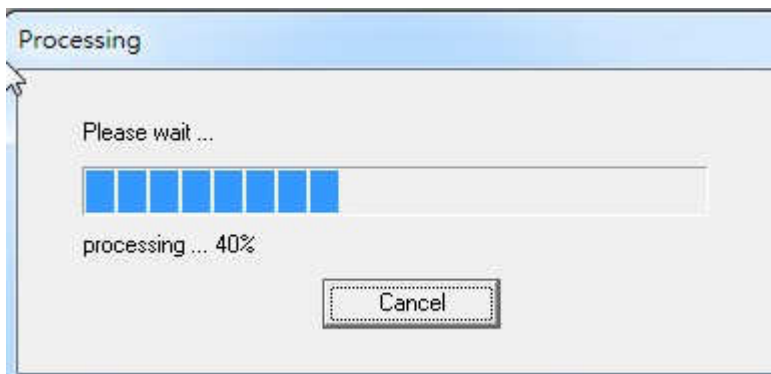

NPort is ready

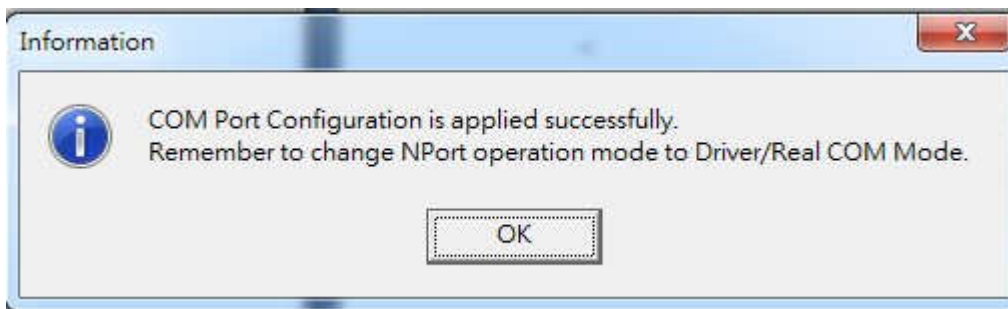



## RF/Antenna output



RF/Antenna output of BNC

The BNC Jack for RF output or for antenna

If RF power under 2 W, the NP-14 antenna can be used by the robber wipe antenna

If RF power over 2W, the NP-14 must use the external antenna., which must be

Set the 1.5 meters away from the NP-14 unit to avoid the interference.

## Folding Antenna

The BNC folding antenna for RF power under 2W use only

If RF power over 2W and UP must using external antenna.

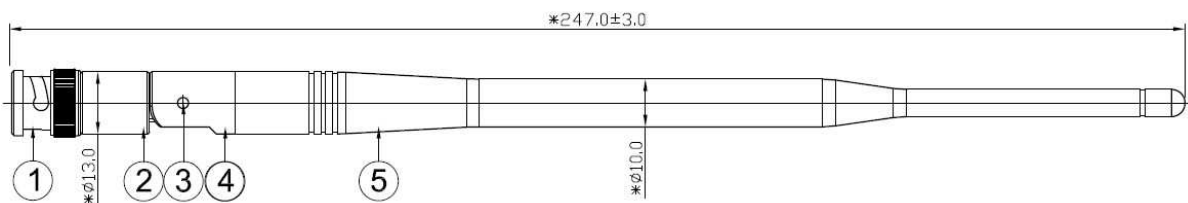

## Mount

Mount on the wall by screw max 5  $\phi$  mm

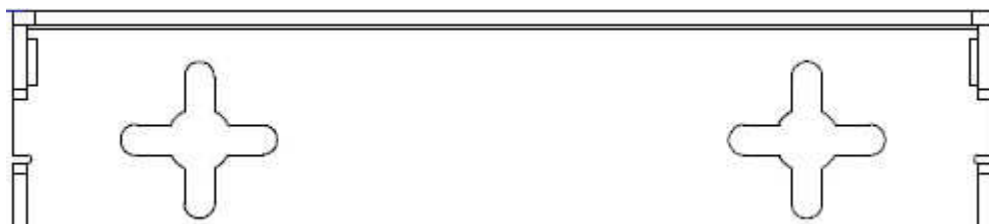

## NP-14 NetPage Paging System Specifications

Frequency:	410-490 MHz Synthesized	868-915 MHz Synthesized
Paging format:	POCSAG.	
Pager Baud rate:	512bps / 1200bps / 2400bps.	
Message type :	ASCII	
Channel Spacing:	6.25K / 12.5K / 25K. Frequency Synthesized by USB programming	
Modulation:	NRZ NFKS, for POCSAG	
Deviation:	3.5-4.5Khz	
Stability:	±10ppm.	
RF output power:	0.1~7 W (programmable)	0.1~4 W (programmable)
RF output connector:	BNC female (SMA female option)	
P/C Interface:	USB 2.0 and RS-232 9600bps	
Ethernet:	RJ-45 TCP/IP 10/100M	
Operation temperature:	-25°C ~ 70°C	
Power Supply:	DC 12V 1A(Minimum)	
Size:	120 mm X 110 mm X 25 mm.	
Model Weight:	0.8KGs. include AC 100~240 to DC 12V 2A switching power adapter.	

Notes: Specifications are subject to change without notice